

 **Flow**

SHAPE TECHNOLOGIES GROUP®

**Mach 100**  
Waterjet Series

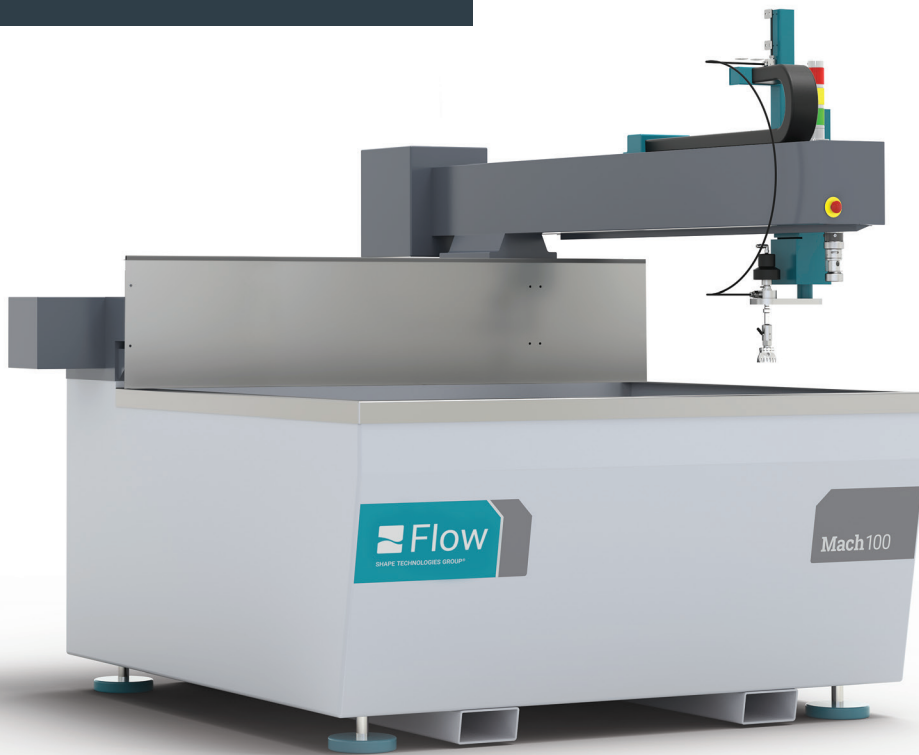

**Mach 100**  
start now.

# Mach 100:

## THE ESSENTIAL WATERJET

Remarkable versatility.  
Maximum value.

Designed to expand your business with minimum investment, the Mach 100 waterjet is a reliable and versatile cutting solution. Made up of the same genuine Flow core components available on our elite waterjets, the Mach 100 gives you the versatility and value to kick start your production, backed by comprehensive service and support.

Whether you're adding new capabilities to your operations, are looking to prototype, or are just getting started in waterjet, the Mach 100 is the key to taking your business to the next level. **Start now.**

**Cold Cutting Process** » No heat or stress is imparted into your cut materials.

**Satin Smooth Edge** » Take the part directly off of the cutting table, no secondary finishing required.

**Minimal Kerf** » Minimal kerf and high accuracy combined with the ability to cut virtually any material means more opportunities.

**PRECISION MOTION SYSTEM**  
High-end ball screw and digital drive system for premium accuracy.

**ADVANCED CUTTING**  
Optimal cut quality and efficiency with Paser<sup>®</sup> 4 cutting head. Use UltraPierce<sup>™</sup> Vacuum Assist for piercing of delicate materials.

**3-SIDED ACCESS**  
Easy loading and unloading of materials.

**ROLL AROUND CONTROL**  
Move freely around your waterjet as you operate your system.

**AUTO-LUBE SYSTEM**  
Automatically lubricates components to ensure continuous peak performance.

**RIGID MACHINE CONSTRUCTION**  
Engineered with durable solid steel construction to support heavy production.



### Pump Selection

Select from a wide array of industry leading pump technology. As the only manufacturer of both Intensifier and Direct Drive pumps, we have the right pump for every application.

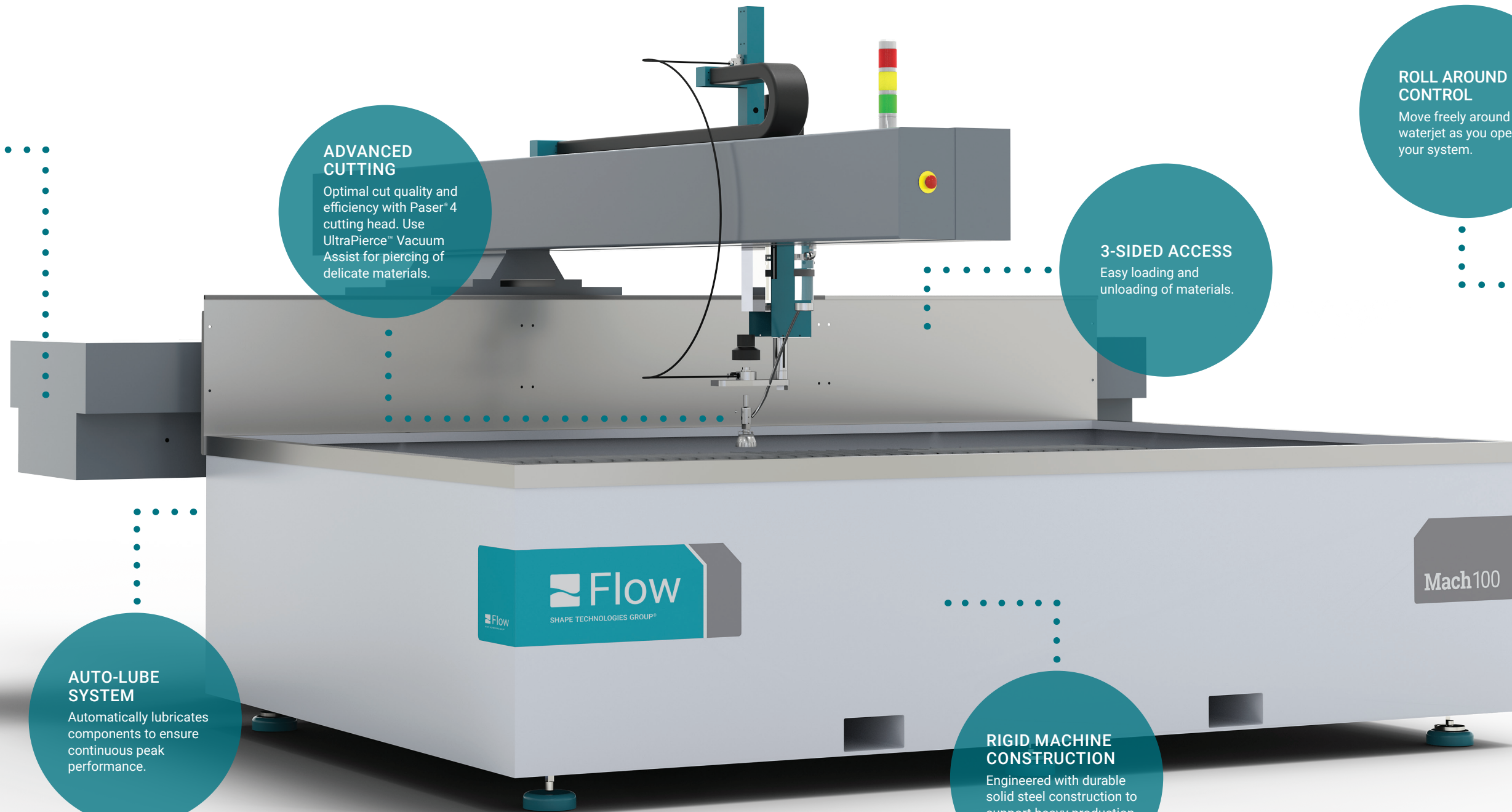

### FlowXpert<sup>®</sup> 3D Modeling CAD/CAM Software Suite

You don't have to be an expert to program a Flow waterjet. With 40+ years of waterjet expertise built in, the software will calculate important specifications behind the scenes for you. Load your part, input material specifications, and start!

# Mach 100 start now.

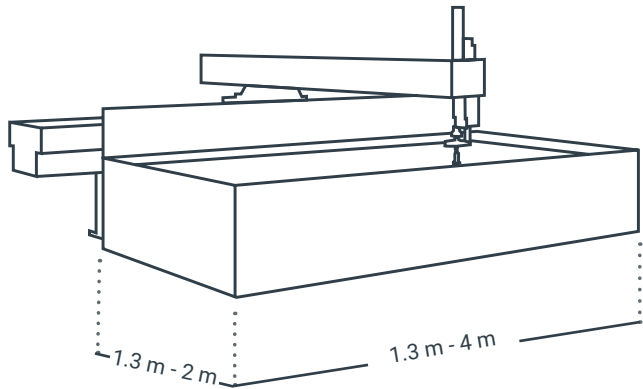

## SPECIFICATIONS & CONFIGURATIONS

Linear Straightness Accuracy	→	± 0.1 mm/m / (± 0.005 in/3 ft)
Rapid Traverse Maximum	→	10 m/min / 400 in/min
Acceleration	→	0.05 g
Repeatability	→	± 0.06 mm / ± 0.0025 in
Ballbar Circularity	→	± 0.1 mm / ± 0.005 in
Z-Axis Travel	→	178 mm / 7 in
Base	→	1.3 – 4 m / 4.3 – 13 ft
Bridge	→	1.3 – 2 m / 4.3 – 6.5 ft

## ANCILLARY OPTIONS & ACCESSORIES

### Service Packages

FlowPath™

FlowNest®

FlowXpert®

FlowCut™

Paser CF900 Continuous Feed Hopper

UltraPierce™ Vacuum Assist

Laser Edge Finder

UNITED STATES & CANADA  
23500 64th Avenue South  
Kent, Washington 98032 USA  
Tel: 253-246-3500  
TOLL-FREE: 800-446-3569  
Fax: 253-813-3285  
info@flowcorp.com  
FlowWaterjet.com

CENTRAL AMERICA, SOUTH AMERICA,  
MEXICO & CARIBBEAN  
Tel: +55-11-3616-2820  
flowlatino@flowcorp.com

EUROPE, MIDDLE EAST & AFRICA  
Tel: +49 (0) 6151 3095-0  
info-germany@flowcorp.com





TAIWAN, CHINA, KOREA, SOUTHEAST  
ASIA, AUSTRALIA & NEW ZEALAND  
Tel: +86-21-5438-2222  
sales.fac@flowcorp.com

JAPAN  
Tel: +81-3-5789-5920  
fjp@flowcorp.com

## Industry Leading Support with FlowCare™

Maximize uptime and profits with our unique FlowCare support. From installation and training, to maintenance and more, we are with you every step of the way.

With FlowCare, we care for your waterjet so you can care for your business.

-  Industry leading service network
-  Rigorously trained Flow technicians
-  Comprehensive operator training programs
-  Applications support for tough cutting needs
-  Delivery of genuine OEM parts



 Flow

SHAPE TECHNOLOGIES GROUP®

 FlowCare